

TECHNICAL SPECIFICATIONS:			
	w/o flasher	W/flasher	R65
Voltage:	Multivoltage (10-30V)	Multivoltage (10-30V)	Multivoltage (10-30V)
Number of LEDs:	3 x 2 W	3 x 2 W	3 x 2 W
Average consumption:	0.2 A (Ref. 2010589, 0.4A)	0.4 A	0.4 A
Average consumption (flashing mode):	0.2 A	0.4 A (blue, white and green) 0.2 A (amber and red)	0.4 A (blue, amber) 0.3 A (red)
Flash patterns:	8 or steady burn	8 + steady burn	R65 + 7 + steady burn
Weight:	80 gr	80 gr	80 gr
Dimensions:	106 x 46 x 25 mm	106 x 46 x 25 mm	106 x 46 x 25 mm

MICROLED ADVANCE Series

LEDs lights

HOW TO ORDER

Choose references from below:

Smooth lens w/o flasher	
2010584	Microled Advance LED directional light, master/slave, 3 LEDs of 2W, amber light, clear smooth lens, w/o flasher, multivoltage
2010589	Microled Advance LED directional light, master/slave, 3 LEDs of 2W, amber light, amber smooth lens, w/o flasher, multivoltage*
2010585	Microled Advance LED directional light, master/slave, 3 LEDs of 2W, blue light, clear smooth lens, w/o flasher, multivoltage
2010586	Microled Advance LED directional light, master/slave, 3 LEDs of 2W, red light, clear smooth lens, w/o flasher, multivoltage
2010587	Microled Advance LED directional light, master/slave, 3 LEDs of 2W, green light, clear smooth lens, w/o flasher, multivoltage
2010636	Microled Advance LED directional light, master/slave, 3 LEDs of 2W, white light, clear smooth lens, w/o flasher, multivoltage
* An external flasher is needed	
Smooth and fresnel V15 lens w/ flasher	
2010573	Microled Advance LED directional light, master/slave, 3 LEDs of 2W, amber light, amber smooth lens, w/flasher, multivoltage
2010580	Microled Advance LED directional light, master/slave, 3 LEDs of 2W, amber light, amber Fresnel V15 lens, w/flasher, multivoltage
2010574	Microled Advance LED directional light, master/slave, 3 LEDs of 2W, amber light, clear smooth lens, w/flasher, multivoltage
2010581	Microled Advance LED directional light, master/slave, 3 LEDs of 2W, amber light, clear Fresnel V15 lens, w/flasher, multivoltage
2010570	Microled Advance LED directional light, master/slave, 3 LEDs of 2W, blue light, blue smooth lens, w/flasher, multivoltage
2010578	Microled Advance LED directional light, master/slave, 3 LEDs of 2W, blue light, blue Fresnel V15 lens, w/flasher, multivoltage
2010571	Microled Advance LED directional light, master/slave, 3 LEDs of 2W, blue light, clear smooth lens, w/flasher, multivoltage
2010579	Microled Advance LED directional light, master/slave, 3 LEDs of 2W, blue light, clear Fresnel V15 lens, w/flasher, multivoltage
2010576	Microled Advance LED directional light, master/slave, 3 LEDs of 2W, red light, clear smooth lens, w/flasher, multivoltage
2010583	Microled Advance LED directional light, master/slave, 3 LEDs of 2W, red light, clear Fresnel V15 lens, w/flasher, multivoltage
2010575	Microled Advance LED directional light, master/slave, 3 LEDs of 2W, red light, red smooth lens, w/flasher, multivoltage
2010582	Microled Advance LED directional light, master/slave, 3 LEDs of 2W, red light, red Fresnel V15 lens, w/flasher, multivoltage
2010577	Microled Advance LED directional light, master/slave, 3 LEDs of 2W, green light, clear smooth lens, w/flasher, multivoltage
2010572	Microled Advance LED directional light, master/slave, 3 LEDs of 2W, white light, clear smooth lens, w/flasher, multivoltage
2010590	Microled Advance LED directional light, master/slave, 3 LEDs of 2W, white light, clear Fresnel V15 lens, w/flasher, multivoltage
Spread R65 lens	
R65 2010595	Microled Advance LED directional light, master/slave, 3 LEDs of 2W, white light, amber spread lens, multivoltage
R65 2010596	Microled Advance LED directional light, master/slave, 3 LEDs of 2W, blue light, blue spread lens, multivoltage
R65 2010597	Microled Advance LED directional light, master/slave, 3 LEDs of 2W, blue light, clear spread lens, multivoltage
R65 2010598	Microled Advance LED directional light, master/slave, 3 LEDs of 2W, red light, clear spread lens, multivoltage
R65 2010599	Microled Advance LED directional light, master/slave, 3 LEDs of 2W, red light, red spread lens, multivoltage

Installation Accesories

2006035	External flasher for MicroLed Plus, (8) flash patterns (UN R65 flash included), multivoltage
2006030	External flasher for (8) lights, (8) flash patterns (UN R65 flash included), multivoltage

Mount Accesories*

2010230	Surface mount kit, (2) joints, (surface mount)
2010231	Flush mount kit, (2) joints, (flush mount)
2010279	L Bracket for permanent mounting
81523056	Fixation platen, 1 Microled Advance**





* Choose a mounting kit when ordering
** (should be folded by the installer)

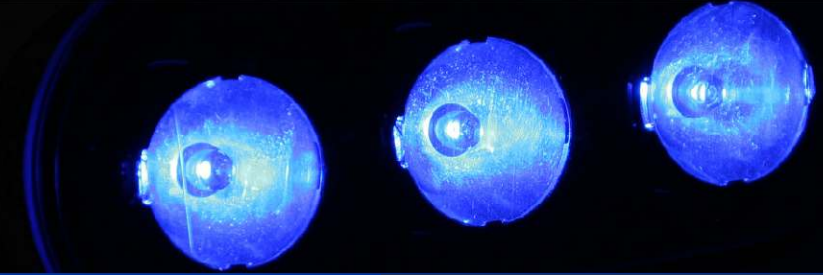

Microled Advance Series



Federal Signal Vama is pleased to announce the introduction of the new Microled Advance supplemental warning LED light. This new addition to Microled range offers additional features and security on emergency situations, and could be installed in almost every place of all emergency vehicle types: rear deck, rearview mirrors, grilles, bumpers, etc. Its main features are:

-  **HIGH INTENSITY.** An ultimate technology LED lights and lenses provide efficient distribution of warning power. Microled Advance offers maximum optical performance with minimal amperage draw.
-  **LONG LIFE.** Federal Signal Vama's LED technology guarantees a long warning light life, helps to reduce maintenance costs, and increases vehicle rotation.
-  **EVERY NEED SOLUTIONS.** Easy to install and with a wide range of solutions: multivoltage references, blue, amber, red or clear lenses, with or without flasher, etc.
-  **WATERPROOF HOUSING.** High density silicone rear sealed, avoiding dust and / or water penetration inside the circuit board. IP protection grade IP9K.

Approvals

Blue, amber and red lights satisfy R65 European Directive. All models satisfy Electromagnetic Compatibility Directive 2004/104. With IP protection IP9K.



Available colours:

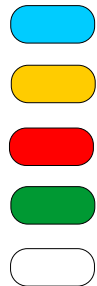

Wide product range



Maximum light intensity.

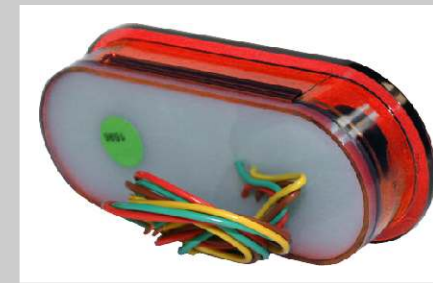

Silicone sealed guarantees no dust and water inside the warning light.



Special Fresnel V15 lens for a light beam inclination, installed on the upper part of the vehicle.



Special spread lens in blue, amber and red, following UN R65 European directive.

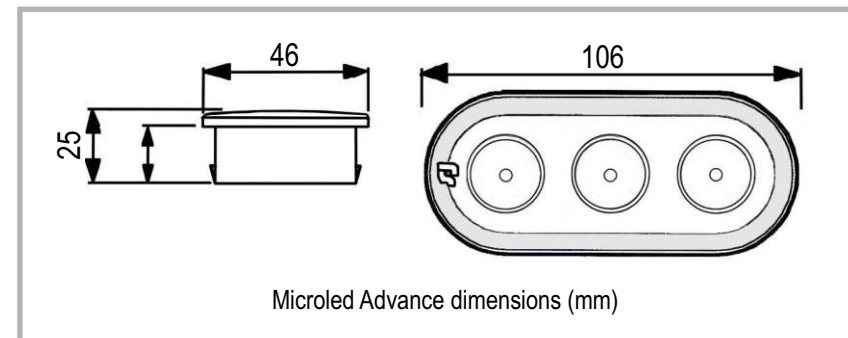

MicroLed Sputnik



MicroLed Advance



MicroLed Advance and Sputnik have fully interchangeable electrical connections for an easy installation.

INSTALLATIONS OPTIONS



Its easy installation and small measurements allow new Microled Advance to work on a undercover emergency situations.



Increased security on the rear part of the vehicle on emergency situations.